



## INFLATABLE CANOES & KAYAKS

Including the following Model Series:  
Sit On Top, Tahiti™, Rio™, Fastback™, Colorado™, Ogden™,  
Ogden Plus™, Big Basin™, Hui Sport, Kiowa™ and Fiji™.

### READ THE FOLLOWING INSTRUCTIONS AND WARNINGS TO AVOID DROWNING OR SERIOUS INJURY



CAUTION:

#### Safety Warning

Paddle sports can be very dangerous and physically demanding. The user of this product should understand that participating in paddle sports may involve serious injury or death. Observe the following safety standards whenever using this product.

- It is the owner's responsibility to carefully read the manual and instruct all users in safe operation of this product.
- Not a life saving device.
- Get paddle sport instruction specific to this type of craft.
- Obtain certified first aid training and carry first aid and safety/rescue equipment.
- Always wear an approved Personal Flotation Device (Life Preserver).
- Wear a helmet when appropriate.
- Dress appropriately for weather conditions; cold water and/or cold weather can result in hypothermia.
- Never paddle alone.
- Do not paddle in flood conditions.
- Be aware of river water levels, tidal changes, dangerous currents and weather changes.
- Do not use in high wind, strong currents, open water or dangerous tides.
- Scout unfamiliar waters; portage when appropriate.
- Do not exceed your paddling ability; be honest with yourself.
- Consult a physician prior to beginning your paddle sport training.
- Do not use this product under the influence of alcohol or drugs.
- Do not make any alterations to this product.
- Do not overload or over inflate.
- Never tow from another boat or vehicle.
- Know and follow local water safety rules and boating regulations.

sevy|or INFLATABLE CANOES & KAYAKS

### IMPORTANT INFORMATION

The warnings below relate to various situations. Please observe them.

#### **⚠ CAUTION!**

Denotes an imminent hazard which will result in severe injury if you do not comply with the instructions.

#### **⚠ WARNING!**

Reminds you of safety measures which must be observed. Also denotes unsafe practices which could result in personal injury or damage to the product or property, if you do not comply with the instructions.

#### **⚠ CAUTION!**

**It is the owner's responsibility to make sure all users carefully read and follow the instructions for safe operation of this product. Observe all local and national laws. Always wear a Personal Flotation Device approved by the proper authorities. Please carefully observe the Capacity Plate information which is printed on the product.**

#### **⚠ WARNING!**

These products are not meant for towing because the extreme pressure of the water while towing can tear the eyelets and/or handles.

These products are made of the highest quality materials and comply with NMMA (National Marine Manufacturers Association) regulations.

#### **⚠ CAUTION!**

Altering the construction of these products could jeopardize the safety of the occupants and will void the limited warranty.

#### **⚠ CAUTION!**

**Do not over inflate. Pressurize product to "Inflation Pressure" stated in the chart for your specific product.**

#### **⚠ WARNING!**

Never use a compressor, CO<sub>2</sub> or compressed air to inflate the product. Do not let your product come into contact with sharp, pointed objects.

#### **⚠ CAUTION!**

Keep product away from gasoline, battery acid, solvents, etc., as they can damage the product.

## INFLATION INSTRUCTIONS

### To inflate using any Sevylor® Pump:

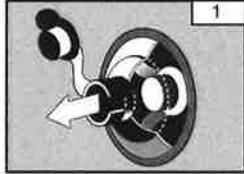

1. To begin inflation, open external cap and pull firmly on the lanyard to extend out. This will open internal yellow seal.

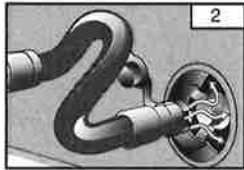

2. Attach nozzle of hose to inflation end of pump. Insert adapter nozzle into valve and start pumping.

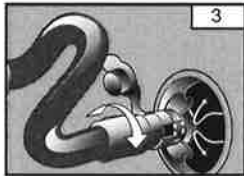

3. When fully inflated, seal valve by pushing in with adapter nozzle. This will seal the internal yellow stopper and keep air from escaping while closing cap. Gently twist adapter while backing hose out of valve.

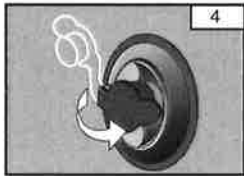

4. Fully remove pump and hose and close external cap. Valve should appear depressed into itself.

### To inflate using any Sevylor® Pump for Boston Valve:

**Boston Valve** is a two-way valve consisting of two parts: the valve insert (center portion) and the square cap on top. To inflate through a Boston valve screw-in the center portion (the end with longer threads) into the valve-base on the bladder and then attach the pump nozzle to it; to deflate unscrew the valve insert (center portion). The square cap with rubber gasket makes the valve air tight once it is screwed onto the valve insert.

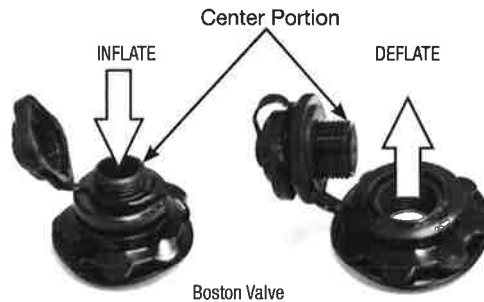

**IMPORTANT!** Inflate the product chambers in the following order:

1. Inflate the floor chamber(s).
2. Inflate the outside main chamber(s).

The chambers on the product will also be numbered to indicate order of inflation also. This order of inflation will ensure the proper volume and buoyancy of the safety chamber.

**Note:** To inflate the mini Double Lock™ valve, which is used on some of the Sevylor® product floors and seat bottoms, follow the same inflation instructions above or previous instructions, using the mini Double Lock™ valve adapter. The mini Double Lock™ valve adapter is included with all Sevylor® pumps. The adapter can be purchased from Sevylor Customer Service by calling 1-800-835-3278 (Part Number 5010000707).

**⚠ CAUTION!**

Water temperature and weather does affect the pressure in inflatable products. In cold weather your product will lose some pressure due to the fact the air will contract. If this occurs, you may want to add a little air to improve your products performance. However, in hot weather, the air will expand. You must let some air out to prevent your product from failing due to overpressure. You should avoid exposing your product to extreme temperatures (hot or cold).

**DEFLATION INSTRUCTIONS**

**Deflation instructions using any Sevylor® Pump:**

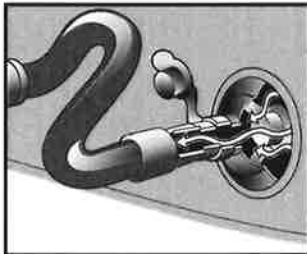

Remove nozzle of hose from inflation end and attach to opposite deflation end of pump. Repeat same steps as inflation. This will draw the air out quickly.

Your product is NMMA certified using the ABYC standard.  using ABYC standards

**⚠ WARNING!**  
Do not exceed the certified maximum capacities under any circumstances!

NMMA (ABYC Standard)	Persons Capacity	Maximum Payload Capacity	Inflation Pressure	Inflation Pressure
Model #	Persons Only	Persons, Gear	Main Chamber(s)	Floor Chamber(s)
Tahiti™ Kayak	2 Pers. or 360 lbs.	360 lbs.	0,9 PSI	0,9 PSI

**⚠ WARNING!**  
Do not exceed the certified maximum capacities under any circumstances!

NMMA (ABYC Standard)	Persons Capacity	Maximum Payload Capacity	Inflation Pressure	Inflation Pressure
Model #	Persons Only	Persons, Gear	Main Chamber(s)	Floor Chamber(s)
Fiji™ Travel Pack Kayak	2 Pers. or 380 lbs.	400 lbs.	0.9 PSI	0.9 PSI

**⚠ WARNING!**  
Do not exceed the certified maximum capacities under any circumstances!

NMMA (ABYC Standard)	Persons Capacity	Maximum Payload Capacity	Inflation Pressure	Inflation Pressure
Model #	Persons Only	Persons, Gear	Main Chamber(s)	Floor Chamber(s)
Clear Creek™ 2 Person	2 Pers. or 360 lbs.	360 lbs.	0,9 PSI	0,9 PSI
Clear Creek™ 3 Person	3 Pers. or 415 lbs.	415 lbs.	0,9 PSI	0,9 PSI

**⚠ WARNING!**  
Do not exceed the certified maximum capacities under any circumstances!

NMMA (ABYC Standard)	Persons Capacity	Maximum Payload Capacity	Inflation Pressure	Inflation Pressure
Model #	Persons Only	Persons, Gear	Main Chamber(s)	Floor Chamber(s)
Colorado™ 2 Person	2 Pers. or 470 lbs.	470 lbs.	1.5 PSI	1.5 PSI

**⚠ WARNING!**

**Do not attempt to mount a motor on any boat does not state a Max. HP engine rating.**

NMMA (ABYC Standard)	Persons Capacity	Maximum Payload Capacity	Engine	Inflation Pressure	Inflation Pressure
Model #	Persons Only	Persons, Gear, Motor (if applicable)	Max. HP Engine	Main Chamber(s)	Floor Chamber(s)
Colorado™ 2 Person FH	2 Pers. or 440 lbs.	500 lbs.	12V Electric Motor Sevylor 2000004144	1.5 PSI	1.5 PSI
Rio™ 1 Person FH	1 Pers. or 350 lbs.	350 lbs.	12V Electric Motor Sevylor 2000004144	1.5 PSI	1.5 PSI

**⚠ WARNING!**

**Do not exceed the certified maximum capacities under any circumstances!**

NMMA (ABYC Standard)	Persons Capacity	Maximum Payload Capacity	Inflation Pressure	Inflation Pressure
Model #	Persons Only	Persons, Gear	Main Chamber(s)	Floor Chamber(s)
1 Person Sit On Top Kayak (Non Covered)	1 Pers. or 400 lbs.	400 lbs.	0.5 PSI	0.5 PSI
2 Person Sit On Top Kayak (Non Covered)	2 Pers. or 595 lbs.	595 lbs.	0.5 PSI	0.5 PSI

**⚠ WARNING!**

**Do not exceed the certified maximum capacities under any circumstances!**

NMMA (ABYC Standard)	Persons Capacity	Maximum Payload Capacity	Inflation Pressure	Inflation Pressure
Model #	Persons Only	Persons, Gear	Main Chamber(s)	Floor Chamber(s)
1 Person Sit On Top Kayak (Covered)	1 Pers. or 250 lbs.	250 lbs.	0.9 PSI	0.9 PSI

NMMA (ABYC Standard)	Persons Capacity	Maximum Payload Capacity	Inflation Pressure	Inflation Pressure
Model #	Persons Only	Persons, Gear	Main Chamber(s)	Floor Chamber(s)
1P Kiowa™	1 Pers. or 250 lbs.	250 lbs.	0.9 PSI	0.9 PSI

**⚠ WARNING!**

**Do not exceed the certified maximum capacities under any circumstances!**

NMMA (ABYC Standard)	Persons Capacity	Maximum Payload Capacity	Inflation Pressure	Inflation Pressure
Model #	Persons Only	Persons, Gear	Main Chamber(s)	Floor Chamber(s)
Ogden™ 2 Person	2 Pers. or 355 lbs.	355 lbs.	1.5 PSI	0.9 PSI
Ogden Plus™ 3 Person	3 Pers. or 460 lbs.	460 lbs.	1.5 PSI	0.9 PSI
Big Basin™ 3 Person	3 Pers. or 490 lbs.	490 lbs.	1.5 PSI	1.5 PSI

**⚠ WARNING!**

**Do not exceed the certified maximum capacities under any circumstances!**

NMMA (ABYC Standard)	Persons Capacity	Maximum Payload Capacity	Inflation Pressure	Inflation Pressure
Model #	Persons Only	Persons, Gear	Main Chamber(s)	Floor Chamber(s)
Fastback™ 1 Person Kayak	1 Pers. or 400 lbs.	400 lbs.	0.5 PSI	0.5 PSI

**⚠ WARNING!**

**Do not exceed the certified maximum capacities under any circumstances!**

NMMA (ABYC Standard)	Persons Capacity	Maximum Payload Capacity	Inflation Pressure	Inflation Pressure
Model #	Persons Only	Persons, Gear	Main Chamber(s)	Floor Chamber(s)
Hui Sport Kayak	1 Pers. or 400 lbs.	400 lbs.	0.5 PSI	0.5 PSI

**⚠ WARNING!**

**Do not exceed the certified maximum capacities under any circumstances!**

### OPERATING INSTRUCTIONS:

- Follow all local boating regulations and navigation rules. Familiarize yourself with boating conditions where you plan to use the boat. Use common sense and caution when operating in unfamiliar places.
- Observe the maximum weight the product can carry and do not overload past this limit. Over-loading jeopardizes the safety of the occupants.
- Be sure all accessories and/or equipment (e.g. oars, life jackets) are in proper working condition before using the boat. Each person occupying the boat is to wear an approved Personal Flotation Device (life preserver).
- Sharp objects are not to be carried in the product without adequate protection or storage.
- When navigating the product in any water depth, watch for submerged or sharp objects that may damage or pierce the boat's air chambers.
- Enter the product from the port (left) or starboard (right) sides - not from the fore (front) or aft (back) sides.
- Never tow with a boat or any other vehicle.

### MOTOR MOUNTING

**⚠ WARNING!**

**ROTATING PROPELLER MAY CAUSE SERIOUS INJURY OR DEATH**  
 •Keep away from the rear of boat while engine is running.

**⚠ WARNING!**

**Do not attempt to mount a motor on any boat does not state a Max. HP engine rating.**

### CARE & STORAGE:

- These products are made of the highest quality materials and comply with NMMA (National Marine Manufacturers Association) regulations. Altering the construction of these products will void the limited warranty and could jeopardize the safety of the occupants.
- If your product has been used in salt water, rinse it off with fresh water as soon as possible.
- Remove tar spots or other soiled areas by using a mild soap and rinsing with fresh water.
- Be sure your product is completely dry before storing.
- The products may be stored inflated, but do not place any heavy or sharp objects on it. Storage is best in a dry room.



### REPAIRING SMALL PUNCTURES

Inadvertent punctures can be repaired using 2 different methods described below.

**Included "Sticky Back Repair Patch"** (included with select models only)

1. Thoroughly clean and dry the damaged area. Completely deflate the product.
2. Cut a portion of the patch to cover the puncture and allow an additional ¼" on all sides. Always cut a round patch, never leave square corners.
3. Be sure the repair area is completely dry.
4. Peel the backing from the patch.
5. Adhere the patch to the puncture.
6. Using your thumb or finger, apply even pressure across the entire surface of the patch.

**Included Vinyl Repair Patch** (included with select models only)

If your model does not include the Sticky Repair Patch noted above, then it will come with a Vinyl Repair Patch. This vinyl repair patch does not include vinyl glue, but it can be purchased from any home or hardware store (PVC cement).

1. Thoroughly clean and dry the damaged area. Completely deflate the product.
2. Cut a portion of the patch to cover the puncture and allow an additional ¼" on all sides. Always cut a round patch, never leave square corners.
3. Be sure the repair area is completely dry.
4. Apply generous coat glue to the vinyl repair patch and to the product.
5. Allow the glue to dry for 2 to 3 minutes, or until the glue becomes tacky.
6. Apply the patch to the product, using your thumb or finger; apply even pressure across the entire surface of the patch. Make sure the edges of the patch are pressed down along the entire diameter.
7. Allow the product to dry for at least 10 hours before inflating and using.

You may purchase the Sevylor® Repair Patch (2000014178) which is a no-glue, pressure sensitive patch great for tears up to 1 inch long. You may also purchase the Sevylor® Air Seal (2000015201) which is a special no patch liquid that will repair pinholes in 5 minutes. These and more products can be found by calling Coleman Customer Service at 1-800-835-3278 or by visiting [www.sevylor.com](http://www.sevylor.com).

**2 PERSON** **Tahiti™** *Optional directional skeg for below model*  
2 Spray Covers

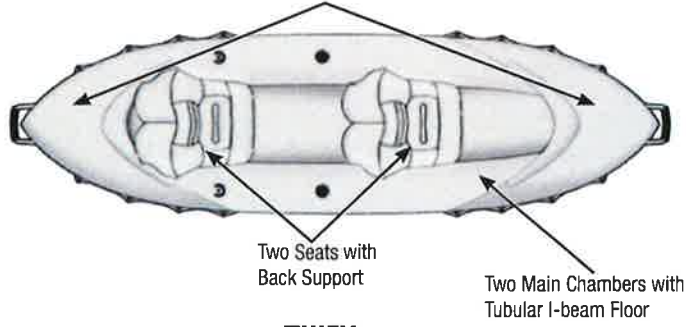

**2 PERSON** **Fiji™**  
2 Spray Covers

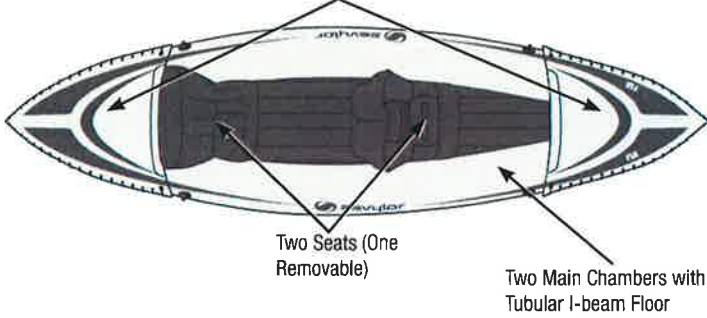

**2 PERSON** **Clear Creek™**  
2 Spray Covers

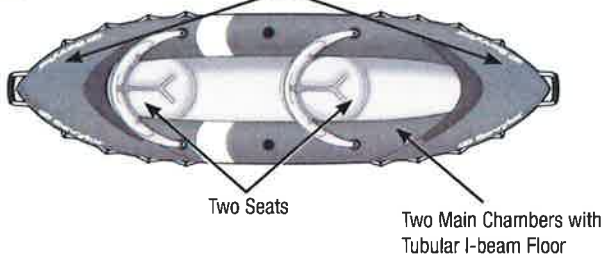

**3 PERSON**  
2 Spray Covers

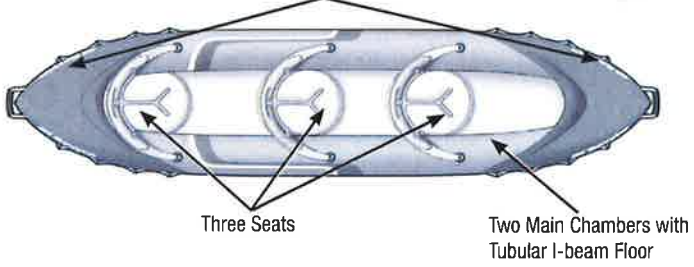

**2 PERSON Colorado™**

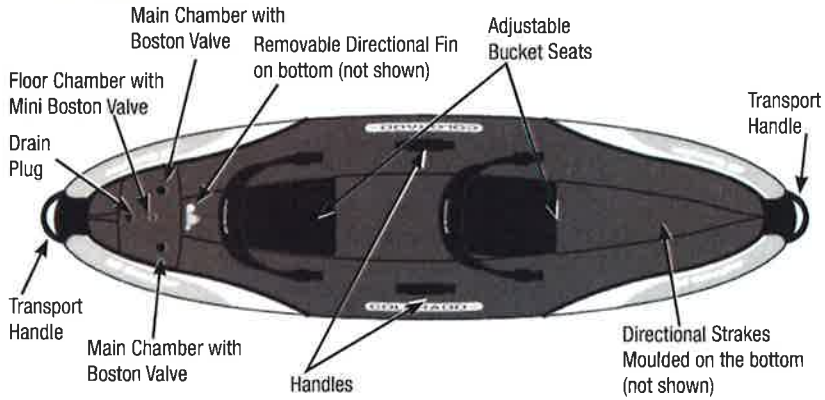

**2 PERSON FH For 2P only**

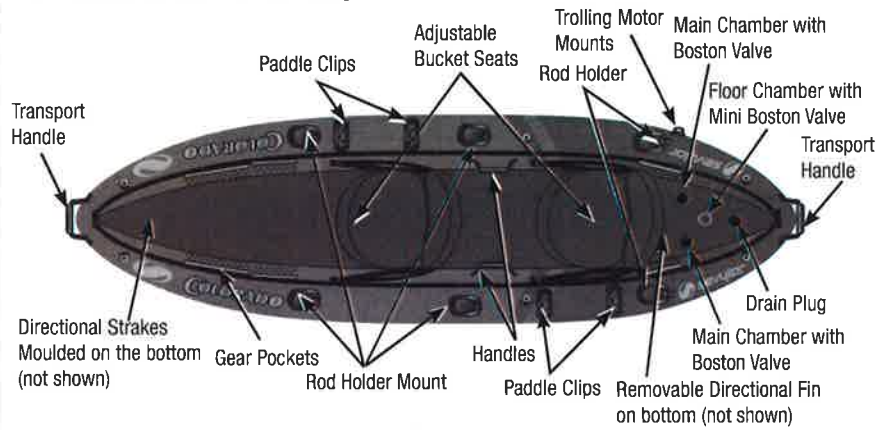

**1 PERSON FH Rio™**

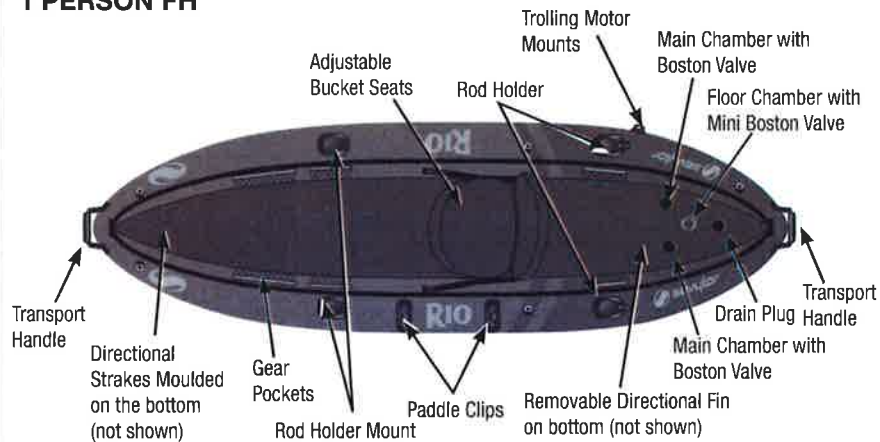

### Sit On Top - Non Covered

#### 1 PERSON

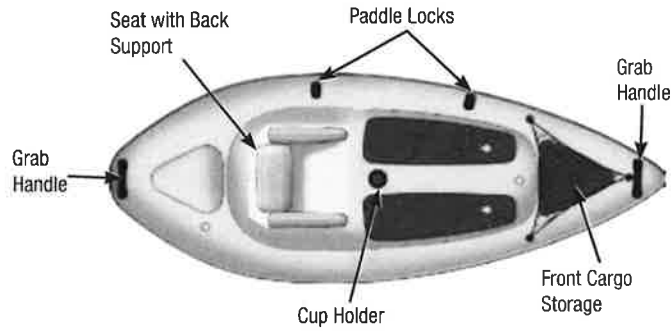

#### 2 PERSON

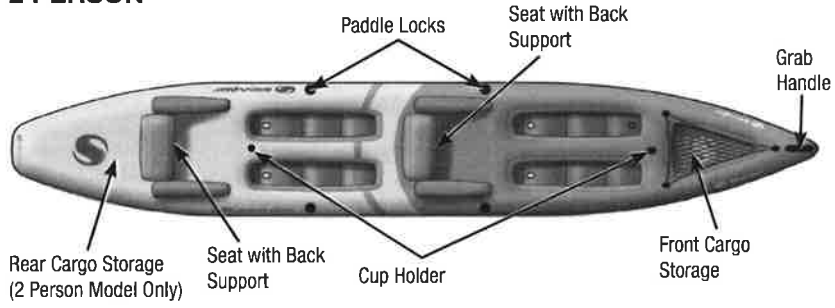

### Sit On Top - Covered

#### 1 PERSON

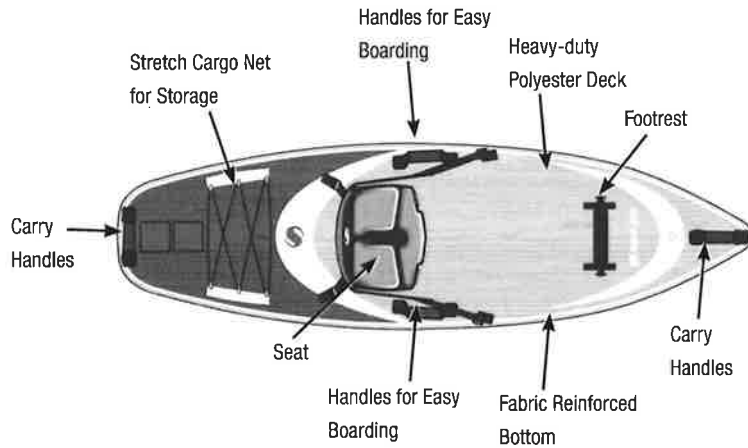

## OGDEN™

**2 PERSON**

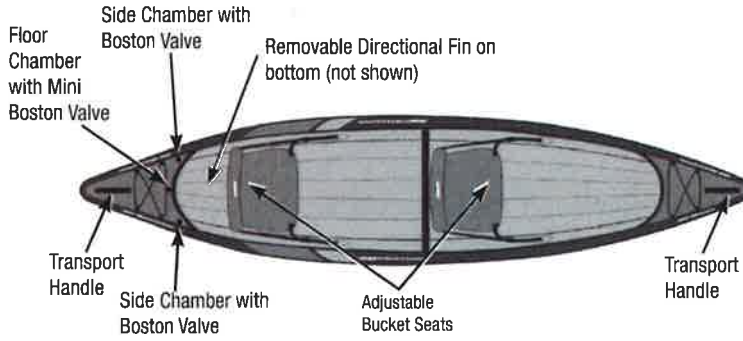

## OGDEN PLUS™

**3 PERSON**

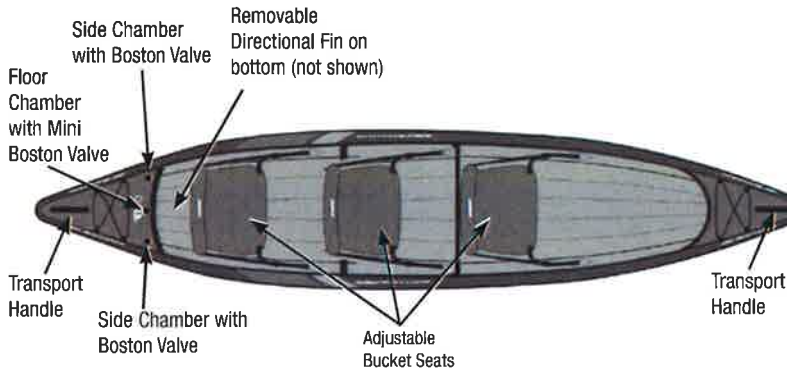

## BIG BASIN™

**3 PERSON**

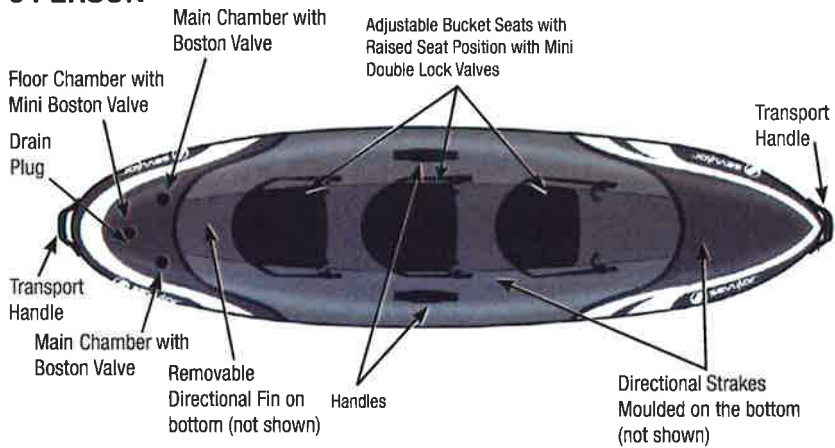

### Fastback™

1 PERSON

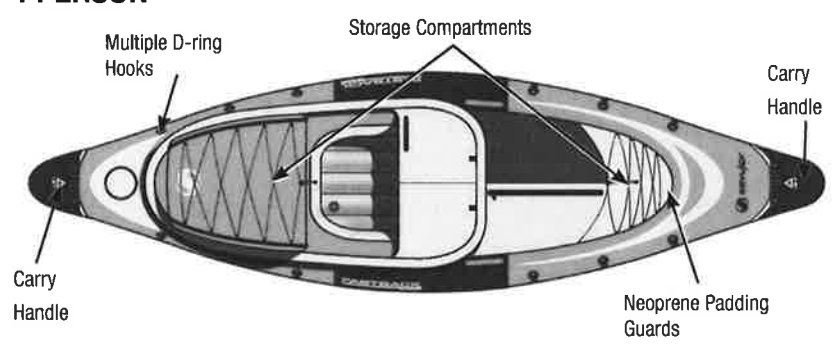

### Hui Sport Kayak

1 PERSON

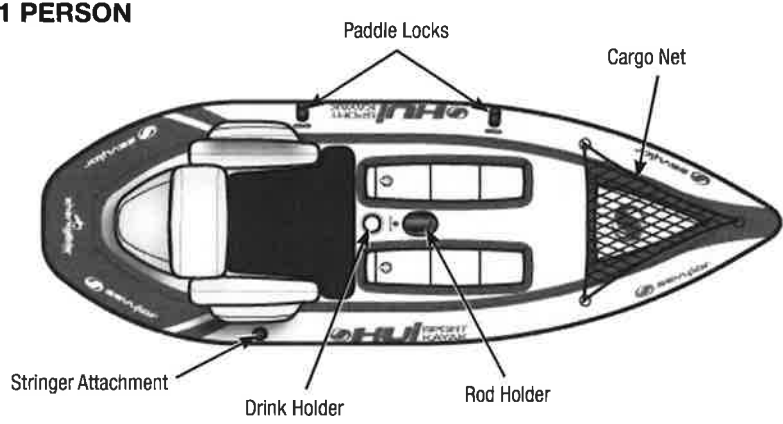

**PADDLE ASSEMBLY:  
SELECT MODELS ONLY.**

Join the three shafts together by screwing them together with the two couplers. Attach the blade to the shafts by screwing onto the end of the shaft.

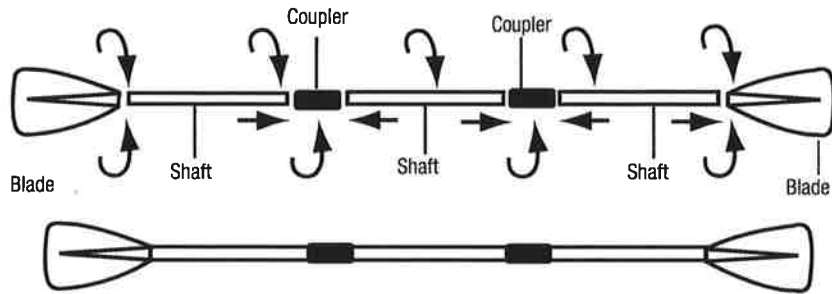

**GUIDELINES FOR USAGE:**

These kayakers may be wider than a typical kayak, which means they may feel more stable. However, as with any narrow, flat bottom kayak, users must be aware of the possibility of the kayak tipping and compensate for it. Paddle with short, even and easy strokes. Paddle close to the kayak with the paddle almost vertical. Pull with one hand and push with the other. If the nose of the kayak is moving right to left you are probably paddling too hard. Ease off on the force of your stroke to reduce the swaying of the front end. Paddling backward or breaking can sometimes offer quick maneuverability.

© 2013 The Coleman Company, Inc. All rights reserved.  
Double Lock™, Tahiti™, Rio™, Fastback™, Colorado™, Fiji™, Ogden™, Ogden Plus™, Big Basin™ and  
Clear Creek™ are trademarks of The Coleman Company, Inc.  
Sevylor® and  are registered trademarks of The Coleman Company, Inc.



3600 North Hydraulic • Wichita, KS 67219 U.S.A.  
1-800-835-3278 • [www.Sevylor.com](http://www.Sevylor.com)

4010025813 (ECN20032990-03)